

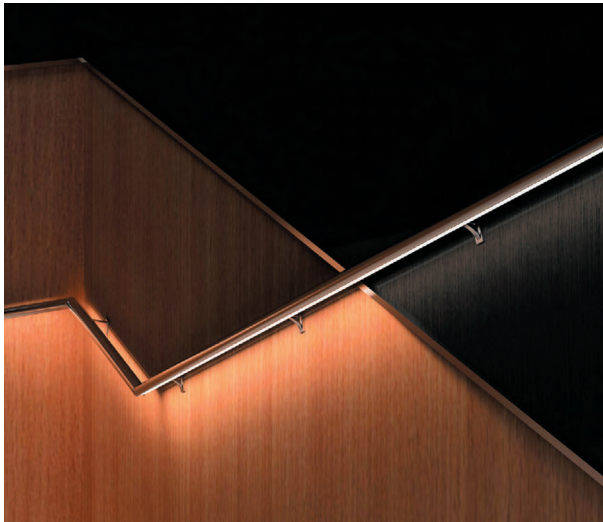

## FoliLED Handrail

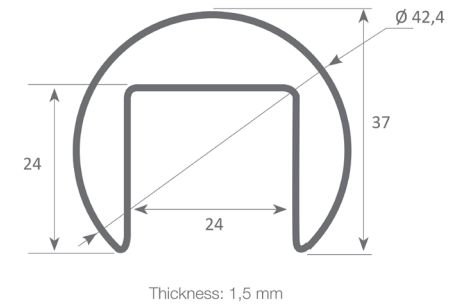

Our led profile series for handrails are manufactured in polished stainless steel or shiny finish on demand. This profile allows us to incorporate led lighting by combining it with our Insert P or Insert V led profile. We also supply a wide range of accessories such as wall supports, endcaps and different types of joints. This steel profile is available in 5-meter lengths, which allows us to carry out long installations without needing any joints. Additional shipping charges may occur for long lengths. Suitable for led strips with a maximum width of 12 mm and a power not greater than 20 W/m. In order to obtain a more homogeneous illumination, we recommend using our opal diffuser. Please specify number of items / meters along with order code.



### ITEM COMPONENTS & ORDER CODES:



Stainless Steel Profile - SSP



Connector - C



Wall Support - WS



Corner Connector - CC



Closing Endcap - CE

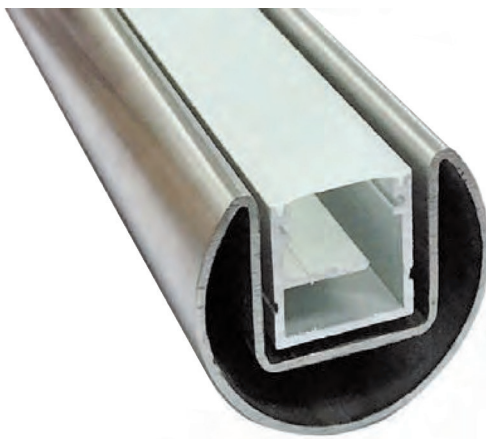

Adjustable Connector  
55° / 20° - AC5520

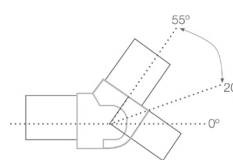

Adjustable Connector  
55° / 20° - AC5520



Adjustable Connector  
70° / 20° - AC7020

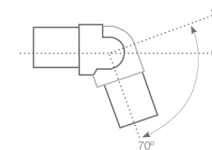

Adjustable Connector  
70° / 20° - AC7020

## FoliLED Handrail Inserts P & V

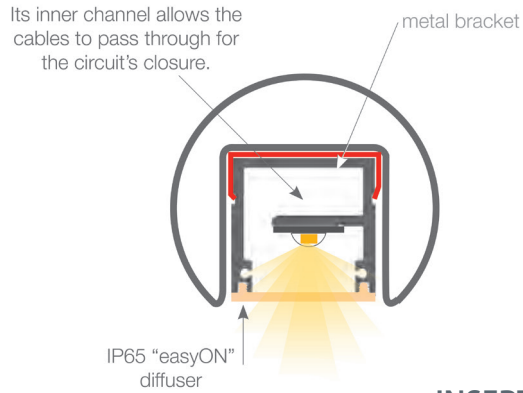

**INSERT V**

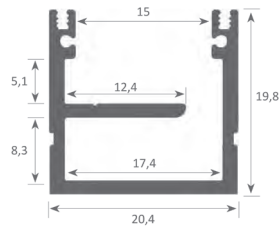

Insert V - dimensions drawing



Insert V Profile - VP



Diffuser - VD



Clip - VC



The above profile allows us to incorporate led lighting by combining it with our

< Insert V

Insert P >

< Example pictures with LED Strip >

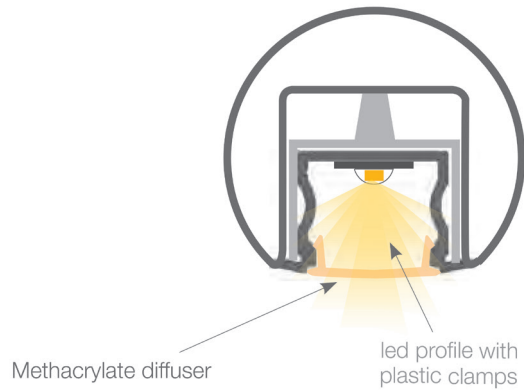
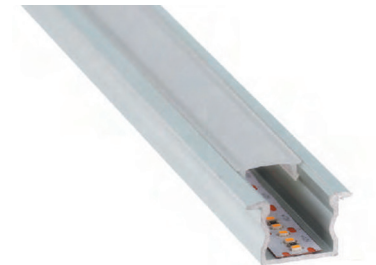

**INSERT P**

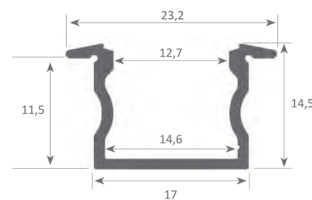

Insert P- dimensions drawing



Insert P Profile - PP



Diffuser - PD

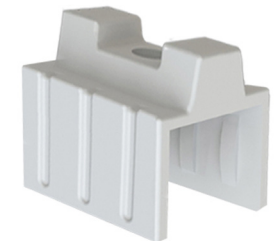

Clip - PC